

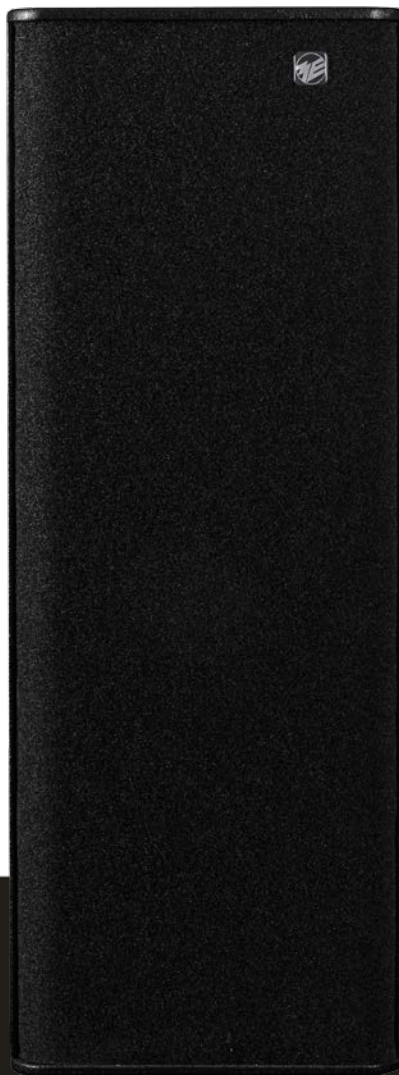

musikelectronic geithain

**TS 37**

**TS 37K**



**Instructions for installation and use**

**Table of contents**

<b>1</b>	<b>Introduction</b>	<b>1</b>
<b>2</b>	<b>Disclaimer</b>	<b>2</b>
<b>3</b>	<b>System description</b>	<b>3</b>
<b>4</b>	<b>Specifications</b>	<b>4</b>
4.1	Technical specifications	4
4.2	Acoustical diagramms	5
4.3	Technical drawings	6
<b>5</b>	<b>Basic information</b>	<b>8</b>
5.1	Guidelines	8
5.2	Disposal	8
5.3	Safety instructions	10
5.4	Delivery contents	12
5.5	Cleaning	12
5.6	Environmental conditions	12
5.7	Guarantee acknowledgements	12
<b>6</b>	<b>Installation and operation</b>	<b>13</b>
6.1	Mounting and positioning	13
6.2	Starting up the speakers	14
6.3	Wiring	15
<b>7</b>	<b>Troubleshooting</b>	<b>16</b>
<b>8</b>	<b>Notes</b>	<b>17</b>

## **1 Introduction**

Dear customer,

Thank you for the trust you have put in us by buying these speakers. You decided upon a quality product that in regard to tonal and technical characteristics complies to the utmost expectations.

The usual burn-in period is not required, because the speakers are artificially aged in-house.

**Please read the technical description and manual to take advantage of the capabilities of these speakers and ensure safe operation.**

## 2 Disclaimer

Technical data and appearances are subject to changes without notice. Errors and omissions excepted. Musikelectronic Geithain GmbH assumes no liability for any loss which may be suffered by any person who relies either wholly or in part upon any description, photograph or statement contained herein. Musikelectronic Geithain GmbH products are sold through authorized fulfillers and resellers only. Fulfillers and resellers are not agents of Musikelectronic Geithain GmbH and have absolutely no authority to bind Musikelectronic Geithain GmbH by any express or implied undertaking or representation. This manual is copyrighted. No part of this manual may be reproduced or transmitted in any form or by any means, electronic or mechanical, including photocopying and recording, or by any information storage or retrieval system without the prior written permission of Musikelectronic Geithain GmbH.

All rights reserved

Copyright © 2023 Musikelectronic Geithain GmbH

### **3 System description**

The TS30 series cover classic sound reinforcement systems in inline technology. High dynamics and limiting level are achieved by special compression drivers with horns. Therefore these products are compatible to existing installations. A technical feature available is our reliable bass cardioid technology. So even in acoustically difficult environments the products of the TS30 series are easy to handle.

The two-way sound reinforcement systems TS37 and TS37K feature linearity and high dynamics. As an all-round system they are useful for speech and music reproduction in middle and large sized auditoria and they are the right decision when systems with high levels are needed.

The components include two 10-inch cone woofers and one 1.4-inch compression driver. The latter is effectively secured from destruction by an internal protective circuit. During the development the high frequency sound transmission was optimised for smallest possible colouration. The bass reflex version TS37 reaches a lower cut-off frequency of 65 Hz. The resulting bass level enables the use as a full-range system in many situations. Optionally our TT-subwoofers can be employed to extend the bass transmission range by more than one octave.

A variety of available mountings provide easy assembly for almost every application.

## 4 Specifications

### 4.1 Technical specifications

Cabinet type	vented cabinet
TS37	cardioid directivity in low frequencies
TS37K	
Maximum SPL	130 dB peak / r = 1 m (3'3")
Frequency response	
TS37	65 Hz ... 18 kHz -6 dB
TS37K	100 Hz ... 18 kHz -6 dB
Coverage angle f > 2 kHz	90° × 40° (H × V) 60° × 40° (H × V)
Transducers	
LF	2 × 10" cone
HF	1 × 1.4" compression driver
Sensitivity	
measured at 1 W	100 dB / r = 1 m (3'3")
Maximum input power	1,200 W
Nominal input power	600 W
Nominal impedance	8 Ω
Electronic crossover frequency	1.5 kHz
Directivity index	see diagram
Input connector	2 × Speakon NL 4 (parallel)
Overload protection	self-resetting
Dimensions (h × w × d)	840 × 320 × 430 mm (33.1" × 12.6" × 17")
Weight	27 kg (59.6 lbs)
Environmental specifications	
Operating temperature	+15 °C ... +35 °C (+59 °F ... +95 °F)
Storage temperature	-25 °C ... +45 °C (-13 °F ... +113 °F)
Relative humidity	45 % ... 75 %
Design of the cabinet	lumber core plywood with scratch proof structure coating black RAL9005, other colours on request
Additional accessories (optional)	security lug stand, wall and ceiling mount elements

## 4.2 Acoustical diagrams

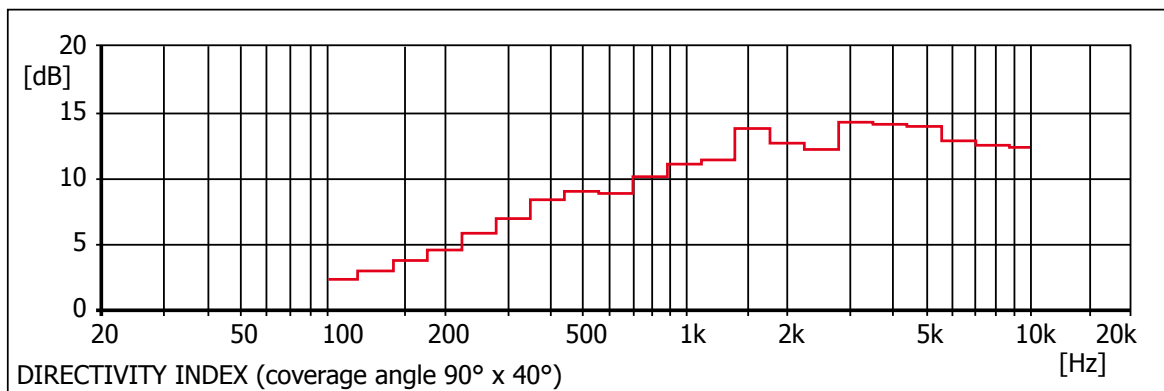
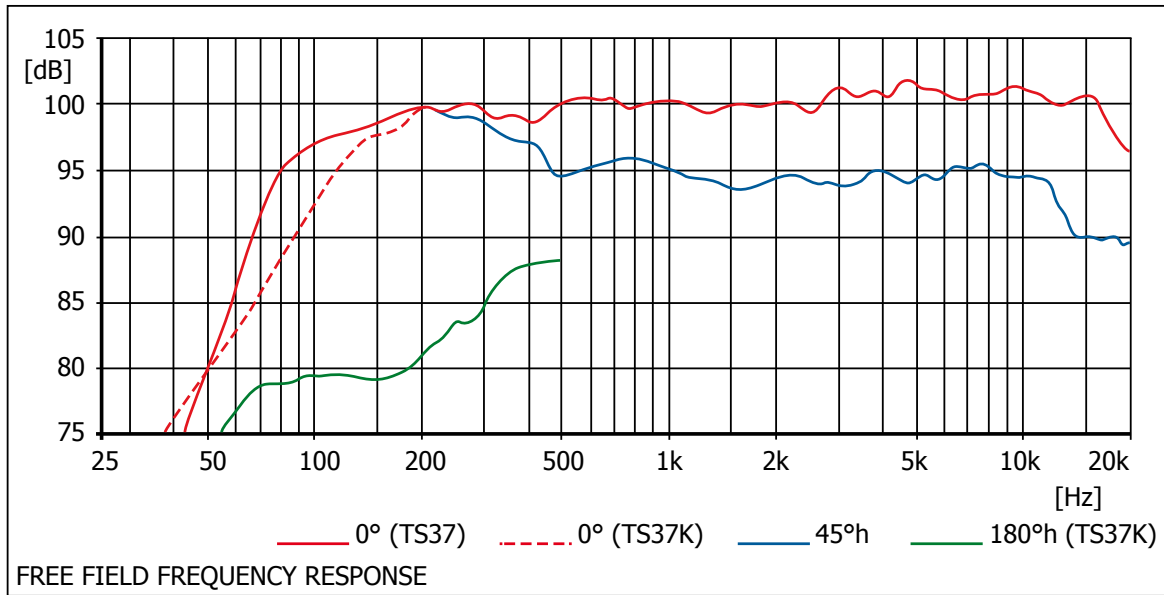

### 4.3 Technical drawings

#### 4.3.1 TS37

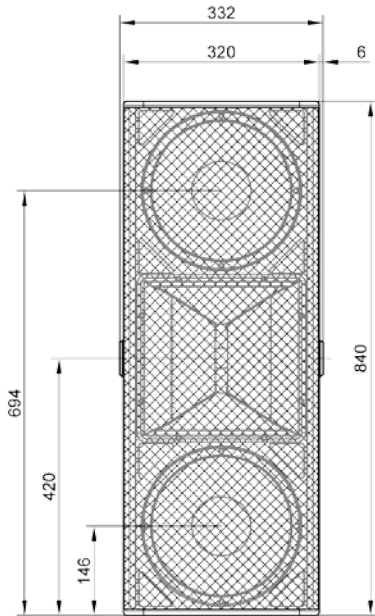

Front view

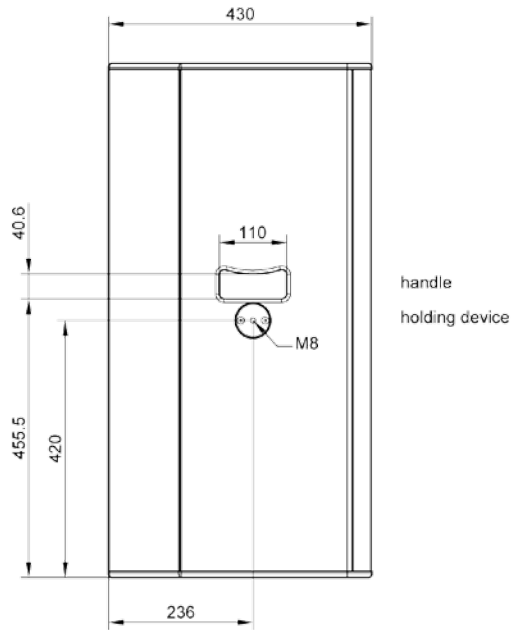

Side view

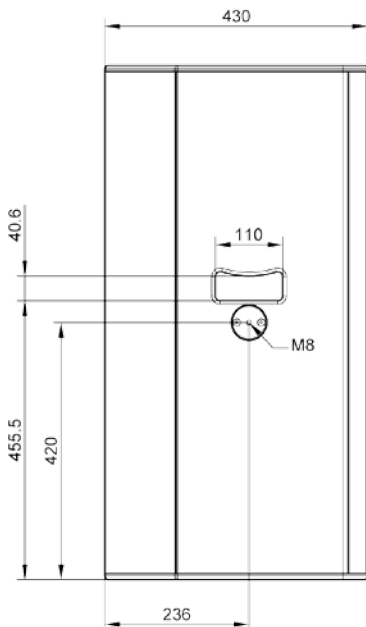

Side view

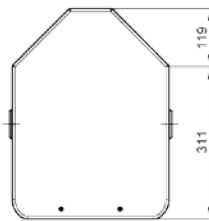

Top view

handle  
holding device

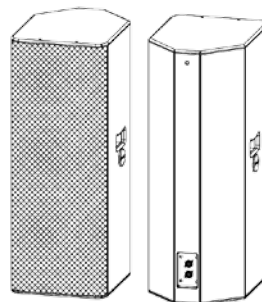



4.3.2 TS37K

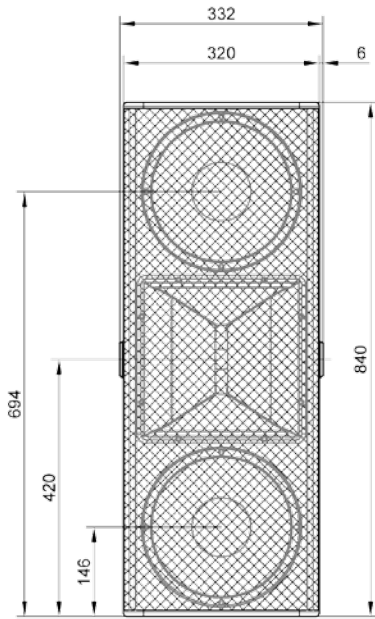

Front view

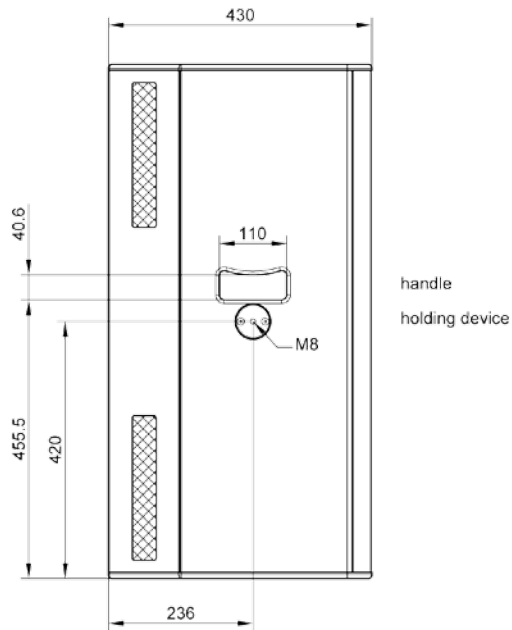

Side view

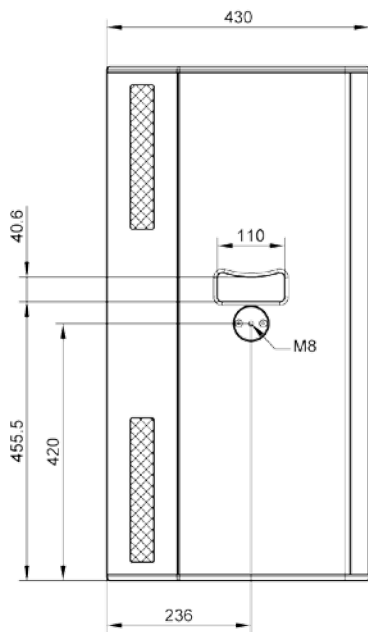

Side view

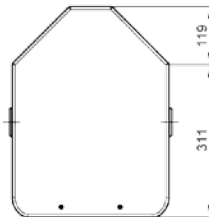

Top view

handle  
holding device

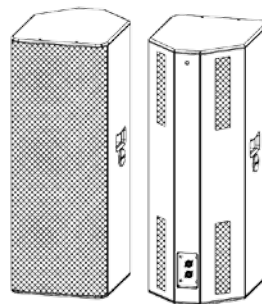

## 5 Basic information

### 5.1 Guidelines

This product complies to requirements of current European and national guidelines. The conformity is ascertained, corresponding declarations and records are deposited with the manufacturer.

#### EC Declaration of Conformity in accordance to EC Directives

- ◄ Electromagnetic Compatibility (2004/108/EG)
- ◄ Low Voltage Directive (2006/95/EG)

#### This product conforms to the following standards:

- ◄ EN55103-1 Emission
- ◄ EN55103-2 Immunity

### 5.2 Disposal

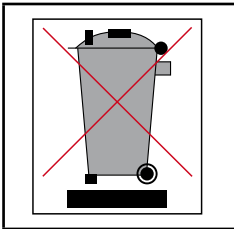

Products built by us belong to B2C-class of the WEEE guidelines and must not be disposed with domestic waste.

#### 5.2.1 Germany

It is not allowed to dispose of used electrical equipment as domestic waste.

Non-reusable parts of the mounting accessories have to be disposed according to national environmental regulations.

Ensure disposal of damaged mounting accessories before they could be reused.

But do not dispose these products and accessories at official collecting points for recycling either!

Disposal of Musikelectronic Geithain GmbH products labelled with a waste bin sign have thus to be disposed of by Musikelectronic Geithain GmbH alone. Please call Musikelectronic Geithain GmbH at the number stated below if you have a Musikelectronic Geithain GmbH product to be disposed. We will offer you a straightforward and professional disposal not affecting cost.

If there is no waste bin sign on one of your Musikelectronic Geithain GmbH products, because they have been sold before March 2006 then by law the owner is in charge of the disposal. For these we will be happy to assist and offer you proper ways of disposal.

Declaration: With the ElektroG (law relating to electrical and electronic equipment and appliances) we have complied with the EU-directive on waste electrical and electronic equipment (WEEE, 2002/96/EC).

The Musikelectronic Geithain GmbH has thus labelled all products mentioned in the WEEE from 03/24/2006 onwards with a sign with a crossed out waste bin and a white bar below. This sign indicates that the disposal into the domestic waste is prohibited and that the product has been put into circulation at the 03/24/2006 earliest.

The Musikelectronic Geithain GmbH has been legally registered as a manufacturer with the registration office EAR. Our WEEE registration No. is: DE 72 4045 19

### **5.2.2 EU, Norway, Iceland and Liechtenstein**

It is not allowed to dispose of used electrical equipment as domestic waste.

The Musikelectronic Geithain GmbH has thus labelled all products coming from EU-Member countries as well as Norway, Iceland and Liechtenstein (except Germany) mentioned in the WEE from 08/13/2005 onwards with a sign with a crossed out waste bin and a white bar below. This sign indicates that the disposal into the domestic waste is prohibited and that the product has been put into circulation at the 08/13/2005 earliest.

Unfortunately the European directive WEEE has been complied with implementing different national provisions of law throughout all member countries, which makes it impossible for us to offer consistent solutions for the disposal throughout Europe.

Responsible for complying with these provisions of law is the local distributor (importer) of each country.

For proper disposition of used products in accordance with these local provisions in the mentioned countries of the European Union (except Germany) please ask your local dealer or the local authorities.

### **5.2.3 Other countries**

For proper disposition of used products in accordance with these local provisions in other countries please ask your local dealer or the local authorities.

### 5.3 Safety instructions

Like using any other electrical device you should observe the following operation guidelines, safety instructions and warning signs to ensure optimum functionality and safety of operation!

- ◀ Read these instructions carefully.
- ◀ Keep these instructions during the life cycle at a safe place. The instructions are an important part of the product.
- ◀ Heed all warnings. Follow all instructions.
- ◀ The product may only be used in accordance with the information provided in the user manual. Before and during the usage of the amplifier please ensure that all recommendations, especially the safety recommendations in the user manual, are adhered to.
- ◀ Do not place this product on an unstable cart, stand, tripod, bracket, or table. The product may fall, causing serious injury, and damage to the product.
- ◀ Do not expose the device to direct sun radiation.
- ◀ Do not try to insert anything into device openings.
- ◀ Do not install the device in rooms with high humidity.
- ◀ The device shall not be exposed to dripping or splashing and no objects filled with liquids shall be placed on the device.
- ◀ Clean only with dry or slightly moistened cloth.
- ◀ Do not attempt to service this product yourself as opening or removing cover may expose you to dangerous voltage or other hazards.
- ◀ There is risk of electric shock when the device is open.
- ◀ Refer all servicing to qualified service personnel.

### **Water, rain, humidity and dust**

The device is not protected against water, rain or excessive humidity and mustn't be exposed to these environmental conditions or operated next to them. Employ appropriate safety measures to prevent dust and dirt to get into the device. Dust and humidity are often the main reason for high voltage creepage paths and serious electrical dangers.

### **Maintenance**

Unplug the device from the mains supply and refer to your authorised retailer or authorised repair and maintenance shop or the manufacturer. Maintenance is only allowed by one of the stated groups, because opening or removing the cover could expose you to dangerous voltages or other dangers. Maintenance is required when ...

- ◀ ... liquid has been spilled or objects have fallen into the device,
- ◀ ... the device has been exposed to rain or moisture,
- ◀ ... the device has been dropped or suffered damage in any other way,
- ◀ ... the device exhibits a distinct change from its normal function or performance.

### **Repair and replacement parts**

All service and repair work must be carried out by an authorised retailer or an authorised repair and maintenance shop or the manufacturer. When replacement parts are required, please ensure that only replacement parts specified by the manufacturer are used. The use of unauthorized replacement parts may result in injury and/or damage through fire or electric shock or other electricity-related hazards.

### **Transport**

To ship this device, always use the original shipping carton and packaging materials. For best protection pack it the same way as the manufacturer.

### **Cleaning**

Unplug the device from the wall outlet before cleaning. Do not use liquid or aerosol cleaners.

### **Correction of damages to the coating / changing the front foam**

Although the used coating is highly resistant, the use of protective covers or flight cases is recommended to avoid damages during transport. If damages to the coating occur despite these precautions, the coating could be restored with acrylic paint in the same RAL colour as the speaker.

### **Signal cord protection**

Signal cords should be routed so that they are not likely to be walked on or pinched by items placed upon them or against them, paying particular attention to cords and plugs, and the point where they exit from the device.

**Interference of external objects and/or liquids with the appliance**

Never push objects of any kind into this product through openings as they may touch dangerous voltage points or short out parts that could result in a fire or electric shock. Never spill liquid of any kind on the device.

**Connecting**

Read the user's manual of the other equipment carefully and follow the instructions when making the connections.

**Sound level**

Reduce the level to minimum before you turn on the speaker to prevent sudden high levels of noise which may cause hearing or speaker damage.

**Unboxing**

The speakers are shipped in proper condition. Unpack the speaker carefully and check for visible damages. In case of damages report them to your retailer. Keep the packaging, in case the speaker has to be transported in the future.

To unpack the device please refer to the additional user manual for unboxing.

**5.4 Delivery contents**

- ◀ Speaker TS37 or TS37K
- ◀ Technical description and user manual

**5.5 Cleaning**

The speaker is made of real wood veneer and needs to be nurtured in the same way as furnishings. We advise quality wax polish to ensure durability of the veneer. Surfaces can also be cleaned with tidy, slightly dampened, fuzz-free, smooth cloth.

**5.6 Environmental conditions**

Ensure the following environmental conditions in your listening room:

- ◀ Operating temperature                    +15 °C ... +35 °C (+59 °F ... +95 °F)
- ◀ Storage temperature range            -25 °C ... +45 °C (-13 °F ... +113 °F)
- ◀ Relative humidity                        45 % ... 75 %

**5.7 Guarantee acknowledgements**

Opening the device by unauthorized personnel leads to all claims under guarantee expire. In case of destruction by overload, misuse or outside influences there are no claims under guarantee.

## **6 Installation and operation**

### **6.1 Mounting and positioning**

#### **6.1.1 Changing the coverage angle of the horn driver**

The horn drivers are designed with a square horn mouth and can be rotated to change the coverage angle. By default, the horn drivers are built-in for a wide horizontal coverage angle.

To widen the coverage angle of the horn driver vertically, the horn can be rotated in the housing. This reduces the horizontal coverage angle. For this purpose, the screws (PH2) at the top and bottom of the device must be removed, which hold the foam-covered front grille. The grille can then be removed carefully. The horn is released by removing further screws (PH2) and then rotating it by 90°. Afterwards the horn is screwed back on, the grille is placed on the device and also screwed back on.

#### **6.1.2 Instructions for mounting and suspension of speakers**

Refer suspending the speakers to trained and qualified personnel.

Heed all warnings and instructions of the speakers and mounting accessories as well as national regulations.

Every speaker is to be suspended with a second independent flying point. This applies also to speakers principally suspended on two flying points. The additional protection suspension has to be attached in that way that in case of failure of the primary suspension the secondary suspension is holding the speaker without falling or swinging. Ensure that all connections are secured to prevent their detaching on their own and that only admissibly statically tested and sufficiently sized connecting devices, ropes and chains are used.

#### **6.1.3 Mounting instructions for speakers**

Speakers are to be mounted in a way, so that they cannot fall and cause damages to environment or persons. Therefore stacked speakers are to be secured with safety straps. Connecting cables have to be installed so that nobody trips.

Stability of stacked systems (including stands and distance rods) is ensured, when the following requirement is fulfilled:

Stacked systems may not fall even if they are inclined more than 10° in any direction. To fulfil this requirement take measures to achieve compliance. One possibility is strapping the stacked speakers to a solid base or using safety straps.

#### **6.1.4 Accurate alignment of the speakers**

The environment heavily influences the result of the sound reinforcement, so absolute statements are not possible. A proper alignment of the speakers leads to hearable increases in quality.

Mid and high range systems should be installed above height of head of the audience to prevent shadowing of sound. A lower installation height results in greater differences in level between front and back seats compared to speakers with higher installation height. Please note that this is just a general guideline and the best possible result may vary from room to room.

#### **6.1.5 Mounting and fastening elements**

Mounting and fastening elements for ceiling, wall or stand installation as well as user specific solutions are available from the retailer or manufacturer.

### **6.2 Starting up the speakers**

Each time a visual inspection and functional check is recommend before starting up the speakers. If there are doubts regarding proper operating condition or safety of the speaker, the speaker mustn't be used.

When chain hoists are in operation ensure nobody is directly underneath or in the vicinity to the load.

#### **6.2.1 Visual inspection**

To reduce risk of accidents by failure or dysfunction of a component all systems need regular checks.

- ◀ visual inspection of all outside parts for obvious damage (e. g. scratches, damages of any kind)
- ◀ visual inspection of all mounting accessories for obvious damage (e. g. scratches, corrosion)
- ◀ inspection of front grille and foam for secure attachment
- ◀ regular lubrication of all sockets with WD-40 or similar products

#### **6.2.2 Functional check**

- ◀ When the system is ready for operation turn up the level on the mixing console. Then the levels of the top cabinets and bass systems should be balanced.



### 6.3 Wiring

- ◀ Turn off all equipment.
- ◀ Use only cables complying with national security regulations. Before use, inspect the cables for obvious damages (e.g. through bends).
- ◀ Switch on peripheral devices (mixing consoles, effects, etc.) first, speakers should be the last devices to be switched on. Stick to this order, otherwise switching noises could damage the systems.
- ◀ In case of noise, turn off all devices in reverse order and check all cable connections. After that switch on the other peripheral devices and check them for interferences.
- ◀ As symmetrical in- and output connectors Speakon sockets are provided
- ◀ Ensure all cables are installed in a way that nobody can trip over them.

## 7 Troubleshooting

Error description	Possible causes	Corrective measures
No sound	Speakers are not connected correctly	Examine the connections to the speakers
	No input signal available	Apply an analogue input signal

## 8 Notes









BDA\_TS37\_TS37K\_25.10.2023\_ENV11



**musikelectronic geithain gmbh**

STUDIO MONITORING - HIGHEND LOUDSPEAKER - SOUND REINFORCEMENT  
SYSTEMS SYSTEMS

Nikolaistraße 7  
04643 Geithain / Germany

Phone: +49 (0) 34341 3110  
Fax: +49 (0) 34341 31144

Email: [info@me-geithain.de](mailto:info@me-geithain.de)

**[www.me-geithain.de](http://www.me-geithain.de)**